

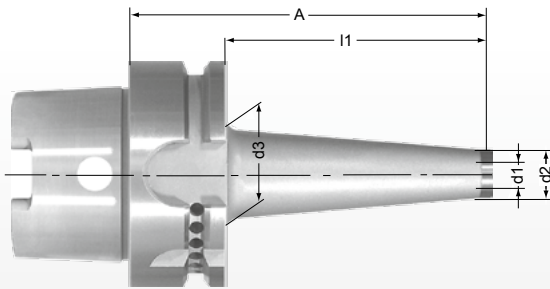

Fräsaufnahme HSK-A32 für Einschraubfräser

shank HSK-A32 for threaded type cutter
mandrin HSK-A32 pour fraises à queue filetée





Bestell-Nr. order number No.	d1	d2	d3	A	l1	 G2,5/15.000 oder/or U<1gmm
920 - A320625	M6	10	15	45	25	
920 - A320650	M6	10	22	70	50	
920 - A320825	M8	13,8	17	45	25	
920 - A320850	M8	13,8	24	70	50	
920 - A321025	M10	18	23	45	25	
920 - A321050	M10	18	25	70	50	
920 - A321225	M12	21	25	45	25	

Fräsaufnahme HSK-A40 für Einschraubfräser

shank HSK-A40 for threaded type cutter

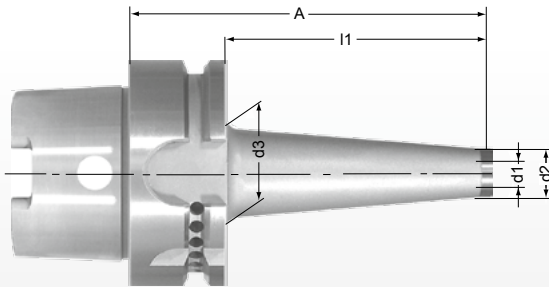
mandrin HSK-A40 pour fraises à queue fileté





Bestell-Nr. order number No.	d1	d2	d3	A	l1	
920 - A400650	M6	10	22	70	50	G2,5/15.000 oder/or U<1gmm
920 - A400675	M6	10	26	95	75	
920 - A400825	M8	13,8	18	45	25	
920 - A400850	M8	13,8	23	70	50	
920 - A400875	M8	13,8	25	95	75	
920 - A4008100	M8	13,8	30	120	100	
920 - A401025	M10	18	23	45	25	
920 - A401050	M10	18	25	70	50	
920 - A401075	M10	18	30	95	75	
920 - A4010100	M10	18	34	120	100	
920 - A401225	M12	21	24	45	25	
920 - A401250	M12	21	30	70	50	
920 - A401275	M12	21	34	95	75	
920 - A401625	M16	29	34	45	25	

Fräsaufnahme HSK-A50 für Einschraubfräser

shank HSK-A50 for threaded type cutter

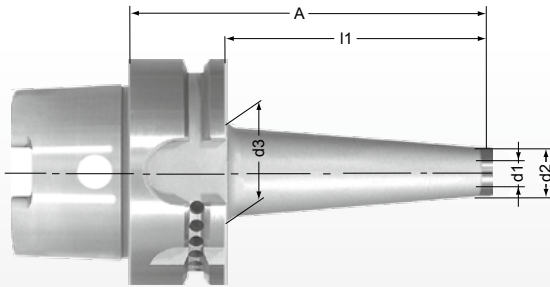
mandrin HSK-A50 pour fraises à queue filetée



Bestell-Nr. order number No.	d1	d2	d3	A	l1	 G2,5/15.000 oder/or U<1gmm
920 - A500625	M 6	10	22	51	25	
920 - A500650	M 6	10	22	76	50	
920 - A500675	M 6	10	26	101	75	
920 - A500825	M 8	13,8	18	51	25	
920 - A500825ZY	M 8	13,8	13,8	51	25	
920 - A500850	M 8	13,8	23	76	50	
920 - A500850ZY	M 8	13,8	13,8	76	50	
920 - A500875	M 8	13,8	25	101	75	
920 - A5008100	M 8	13,8	30	126	100	
920 - A5008125	M 8	13,8	36	151	125	
920 - A501025	M 10	18	23	51	25	
920 - A501025ZY	M 10	18	18	51	25	
920 - A501050	M 10	18	25	76	50	
920 - A501050ZY	M 10	18	18	76	50	
920 - A501075	M 10	18	30	101	75	
920 - A5010100	M 10	18	35	126	100	
920 - A5010125	M 10	18	41	151	125	
920 - A501225	M 12	21	24	51	25	
920 - A501250	M 12	21	30	76	50	
920 - A501250ZY	M 12	23	23	76	50	
920 - A501275	M 12	21	35	101	75	
920 - A501275ZY	M 12	23	23	101	75	
920 - A5012100	M 12	21	38	126	100	
920 - A5012125	M 12	21	42	151	125	
920 - A501625	M 16	29	29	51	25	
920 - A501650	M 16	29	34	76	50	
920 - A501650ZY	M 16	29	29	76	50	
920 - A501675	M 16	29	35	101	75	
920 - A501675ZY	M 16	29	29	101	75	
920 - A5016100	M 16	29	40	126	100	
920 - A5016125	M 16	29	42	151	125	

Fräsaufnahme HSK-A63 für Einschraubfräser

shank HSK-A63 for threaded type cutter

mandrin HSK-A63 pour fraises à queue filetée

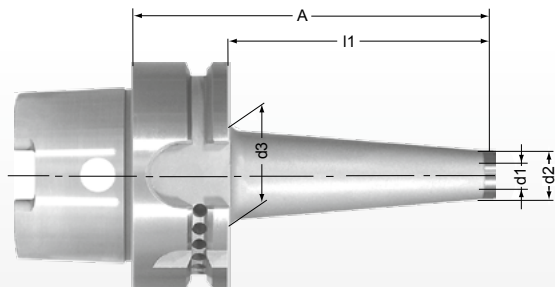

Bestell-Nr. order number No.	d1	d2	d3	A	l1	G2,5/15.000
920 - A630625	M 6	10	22	51	25	
920 - A630650	M 6	10	22	76	50	
920 - A630675	M 6	10	26	101	75	
920 - A630825	M 8	13,8	18	51	25	
920 - A630825ZY	M 8	13,8	13,8	51	25	
920 - A630850	M 8	13,8	23	76	50	
920 - A630850ZY	M 8	13,8	13,8	76	50	
920 - A630875	M 8	13,8	25	101	75	
920 - A630875ZY	M 8	13,8	13,8	101	75	
920 - A6308100	M 8	13,8	30	126	100	
920 - A6308125	M 8	13,8	32	151	125	
920 - A6308200	M 8	13,8	50	226	200	
920 - A631025	M 10	18	23	51	25	
920 - A631025ZY	M 10	18	18	51	25	
920 - A631050	M 10	18	25	76	50	
920 - A631050ZY	M 10	18	18	76	50	
920 - A631075	M 10	18	30	101	75	
920 - A631075ZY	M 10	18	18	101	75	
920 - A6310100	M 10	18	35	126	100	
920 - A6310100ZY	M 10	18	18	126	100	
920 - A6310125	M 10	18	40	151	125	
920 - A6310125ZY	M 10	18	18	151	125	
920 - A6310150	M 10	18	44	176	150	
920 - A6310200	M 10	18	50	226	200	
920 - A631225	M 12	21	24	51	25	
920 - A631250	M 12	21	30	76	50	
920 - A631250ZY	M 12	23	23	76	50	
920 - A631275	M 12	21	35	101	75	
920 - A631275ZY	M 12	23	23	101	75	
920 - A6312100	M 12	21	38	126	100	
920 - A6312100ZY	M 12	23	23	126	100	
920 - A6312125	M 12	21	43	151	125	
920 - A6312150	M 12	21	45	176	150	
920 - A6312175	M 12	21	46	201	175	
920 - A6312200	M 12	21	46	226	200	

Fräsaufnahme HSK-A63 für Einschraubfräser

shank HSK-A63 for threaded type cutter
mandrin HSK-A63 pour fraises à queue filetée

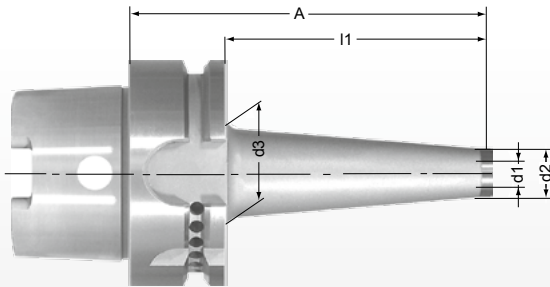



Bestell-Nr. order number No.	d1	d2	d3	A	l1	
920 - A631625	M 16	29	29	51	25	G2,5/15.000
920 - A631650	M 16	29	34	76	50	
920 - A631650-37	M 16	37	43	76	50	
920 - A631650ZY	M 16	29	29	76	50	
920 - A631650ZY-37	M 16	37	37	76	50	
920 - A631675	M 16	29	35	101	75	
920 - A631675-37	M 16	37	46	101	75	
920 - A631675ZY	M 16	29	29	101	75	
920 - A631675ZY-37	M 16	37	37	101	75	
920 - A6316100	M 16	29	40	126	100	
920 - A6316100-37	M 16	37	49	126	100	
920 - A6316100ZY	M 16	29	29	126	100	
920 - A6316125	M 16	29	44	151	125	
920 - A6316150	M 16	29	47	176	150	
920 - A6316150ZY	M 16	29	29	176	150	
920 - A6316175	M 16	29	52	201	175	
920 - A6316200	M 16	29	52	226	200	
920 - A6316200ZY	M 16	29	29	226	200	
920 - A6316250	M 16	29	52	276	250	

Fräsaufnahme HSK-A80 für Einschraubfräser

shank HSK-A80 for threaded type cutter

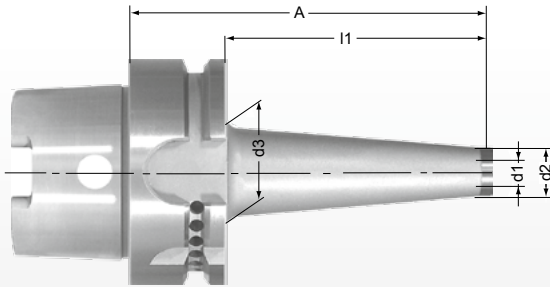
mandrin HSK-A80 pour fraises à queue filetée





Bestell-Nr. order number No.	d1	d2	d3	A	l1	
920 - A800825	M 8	13,8	18	51	25	G2,5/15.000
920 - A800850	M 8	13,8	23	76	50	
920 - A8008100	M 8	13,8	30	126	100	
920 - A801025	M 10	18	23	51	25	
920 - A801050	M 10	18	25	76	50	
920 - A801075	M 10	18	30	101	75	
920 - A8010100	M 10	18	35	126	100	
920 - A801225	M 12	21	24	51	25	
920 - A801250	M 12	21	30	76	50	
920 - A801275	M 12	21	35	101	75	
920 - A8012100	M 12	21	40	126	100	
920 - A8012125	M 12	21	43	151	125	
920 - A801625	M 16	29	29	51	25	
920 - A801650	M 16	29	34	76	50	
920 - A801650ZY	M 16	29	29	76	50	
920 - A801650ZY-37	M 16	37	37	76	50	
920 - A801675	M 16	29	37	101	75	
920 - A8016100	M 16	29	40	126	100	
920 - A8016100-37	M 16	37	49	126	100	
920 - A8016125	M 16	29	44	126	100	
920 - A8016150	M 16	29	50	176	150	
920 - A8016200	M 16	29	60	226	200	

Fräsaufnahme HSK-A100 für Einschraubfräser

shank HSK-A100 for threaded type cutter

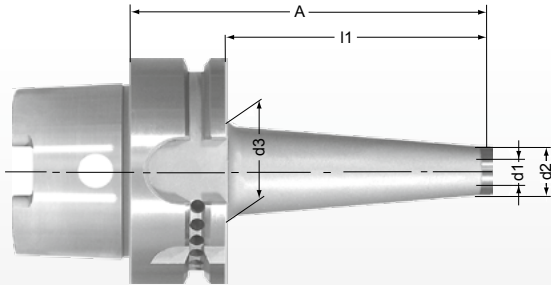
mandrin HSK-A100 pour fraises à queue fileté



Bestell-Nr. order number No.	d1	d2	d3	A	l1	
920 - A1000850	M 8	13,8	28	79	50	
920 - A1000875	M 8	13,8	30	104	75	
920 - A10008100	M 8	13,8	30	129	100	
920 - A10008150	M 8	13,8	33	179	150	
920 - A10008200	M 8	13,8	38	229	200	
920 - A1001050	M 10	18	30	79	50	
920 - A1001075	M 10	18	33	104	75	
920 - A10010100	M 10	18	35	129	100	
920 - A10010125	M 10	18	35	154	125	
920 - A10010150	M 10	18	38	179	150	
920 - A10010200	M 10	18	40	229	200	
920 - A1001230	M 12	21	30	59	30	
920 - A1001250	M 12	21	33	79	50	
920 - A1001275	M 12	21	35	104	75	
920 - A10012100	M 12	21	38	129	100	
920 - A10012125	M 12	21	43	154	125	
920 - A10012150	M 12	21	45	179	150	
920 - A10012200	M 12	21	50	229	200	
920 - A10012250	M 12	21	60	279	250	
920 - A10012300	M 12	21	70	329	300	
920 - A1001630	M 16	29	32	59	30	
920 - A1001650	M 16	29	34	79	50	
920 - A1001650ZY	M 16	29	29	79	50	
920 - A1001650ZY-37	M 16	37	37	79	50	
920 - A1001675	M 16	29	35	104	75	
920 - A1001675ZY	M 16	29	29	104	75	
920 - A1001675ZY-37	M 16	37	37	104	75	
920 - A10016100	M 16	29	40	129	100	
920 - A10016100ZY	M 16	29	29	129	100	
920 - A10016100ZY-37	M 16	37	37	129	100	
920 - A10016125	M 16	29	45	154	125	
920 - A10016150	M 16	29	50	179	150	
920 - A10016200	M 16	29	60	229	200	
920 - A10016250	M 16	29	70	279	250	
920 - A10016300	M 16	29	80	329	300	

Fräsaufnahme HSK-E32 für Einschraubfräser

shank HSK-E32 for threaded type cutter
mandrin HSK-E32 pour fraises à queue fileté

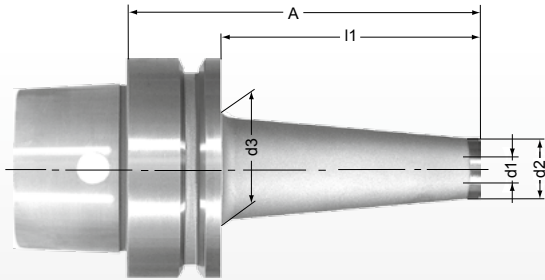



Bestell-Nr. order number No.	d1	d2	d3	A	l1	 G2,5/15.000 oder/or U<1gmm
920 - E320650	M6	10	22	70	50	
920 - E320825	M8	13,8	17	45	25	
920 - E320850	M8	13,8	24	70	50	
920 - E321025	M10	18	23	45	25	
920 - E321050	M10	18	25	70	50	
920 - E321225	M12	21	25	45	25	

Fräsaufnahme HSK-E40 für Einschraubfräser

shank HSK-E40 for threaded type cutter

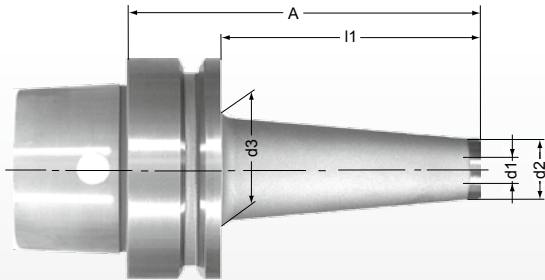
mandrin HSK-E40 pour fraises à queue fileté



Bestell-Nr. order number No.	d1	d2	d3	A	l1	
920 - E400525	M5	10	18	45	25	G2,5/15.000 oder/or U<1gmm
920 - E400550	M5	10	22	70	50	
920 - E400575	M5	10	26	95	75	
920 - E400625	M6	10	18	45	25	
920 - E400650	M6	10	22	70	50	
920 - E400675	M6	10	26	95	75	
920 - E400825	M8	13,8	18	45	25	
920 - E400850	M8	13,8	23	70	50	
920 - E400875	M8	13,8	25	95	75	
920 - E4008100	M8	13,8	30	120	100	
920 - E401025	M10	18	23	45	25	
920 - E401050	M10	18	25	70	50	
920 - E401075	M10	18	30	95	75	
920 - E4010100	M10	18	34	120	100	
920 - E401225	M12	21	24	45	25	
920 - E401250	M12	21	30	70	50	
920 - E401275	M12	21	34	95	75	
920 - E401625	M16	29	34	45	25	

Fräsaufnahme HSK-E50 für Einschraubfräser

shank HSK-E50 for threaded type cutter
mandrin HSK-E50 pour fraises à queue filetée

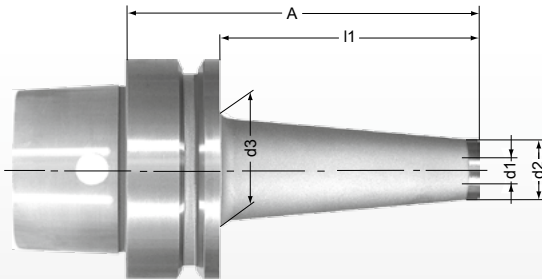

Bestell-Nr. order number No.	d1	d2	d3	A	l1	 G2,5/15.000 oder/or U<1gmm
920 - E500625	M 6	10	22	51	25	
920 - E500650	M 6	10	22	76	50	
920 - E500675	M 6	10	26	101	75	
920 - E500825	M 8	13,8	18	51	25	
920 - E500825ZY	M 8	13,8	13,8	51	25	
920 - E500850	M 8	13,8	23	76	50	
920 - E500850ZY	M 8	13,8	13,8	76	50	
920 - E500875	M 8	13,8	25	101	75	
920 - E5008100	M 8	13,8	30	126	100	
920 - E5008125	M 8	13,8	36	151	125	
920 - E501025	M 10	18	23	51	25	
920 - E501025ZY	M 10	18	18	51	25	
920 - E501050	M 10	18	25	76	50	
920 - E501050ZY	M 10	18	18	76	50	
920 - E501075	M 10	18	30	101	75	
920 - E5010100	M 10	18	35	126	100	
920 - E5010125	M 10	18	41	151	125	
920 - E501225	M 12	21	24	51	25	
920 - E501250	M 12	21	30	76	50	
920 - E501250ZY	M 12	23	23	76	50	
920 - E501275	M 12	21	35	101	75	
920 - E501275ZY	M 12	23	23	101	75	
920 - E5012100	M 12	21	38	126	100	
920 - E5012125	M 12	21	42	151	125	
920 - E501625	M 16	29	29	51	25	
920 - E501650	M 16	29	34	76	50	
920 - E501650ZY	M 16	29	29	76	50	
920 - E501675	M 16	29	35	101	75	
920 - E501675ZY	M 16	29	29	101	75	
920 - E5016100	M 16	29	40	126	100	
920 - E5016125	M 16	29	42	151	125	

Fräsaufnahme HSK-E63 für Einschraubfräser

shank HSK-E63 for threaded type cutter
mandrin HSK-E63 pour fraises à queue filetée

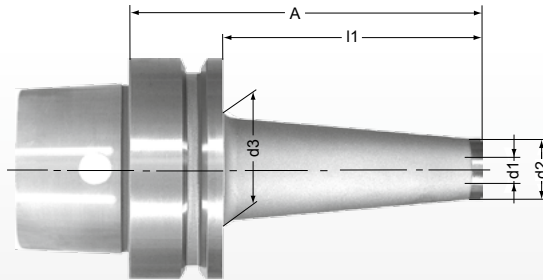

Bestell-Nr. order number No.	d1	d2	d3	A	l1	
920 - E630625	M 6	10	22	51	25	G2,5/15.000
920 - E630650	M 6	10	22	76	50	
920 - E630825	M 8	13,8	18	51	25	
920 - E630825ZY	M 8	13,8	13,8	51	25	
920 - E630850	M 8	13,8	23	76	50	
920 - E630850ZY	M 8	13,8	13,8	76	50	
920 - E630875	M 8	13,8	25	101	75	
920 - E6308100	M 8	13,8	30	126	100	
920 - E6308125	M 8	13,8	32	151	125	
920 - E631025	M 10	18	23	51	25	
920 - E631025ZY	M 10	18	18	51	25	
920 - E631050	M 10	18	25	76	50	
920 - E631050ZY	M 10	25	25	76	50	
920 - E631075	M 10	18	30	101	75	
920 - E631075ZY	M 10	18	18	101	75	
920 - E6310100	M 10	18	35	126	100	
920 - E6310125	M 10	18	40	151	125	
920 - E6310150	M 10	18	44	176	150	
920 - E631225	M 12	21	24	51	25	
920 - E631250	M 12	21	30	76	50	
920 - E631250ZY	M 12	23	23	76	50	
920 - E631275	M 12	21	35	101	75	
920 - E631275ZY	M 12	23	23	101	75	
920 - E6312100	M 12	21	38	126	100	
920 - E6312100ZY	M 12	23	23	126	100	
920 - E6312125	M 12	21	43	151	125	
920 - E6312150	M 12	21	45	176	150	
920 - E6312175	M 12	21	46	201	175	
920 - E6312200	M 12	21	46	226	200	

Fräsaufnahme HSK-E63 für Einschraubfräser

shank HSK-E63 for threaded type cutter
mandrin HSK-E63 pour fraises à queue filetée

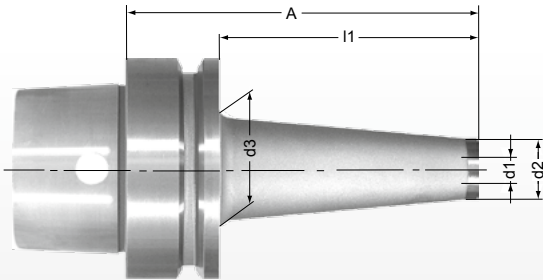

Bestell-Nr. order number No.	d1	d2	d3	A	l1	
920 - E631625	M 16	29	29	51	25	G2,5/15.000
920 - E631650	M 16	29	34	76	50	
920 - E631650ZY	M 16	29	29	76	50	
920 - E631675	M 16	29	35	101	75	
920 - E631675ZY	M 16	29	29	101	75	
920 - E6316100	M 16	29	40	126	100	
920 - E6316100ZY	M 16	29	29	126	100	
920 - E6316125	M 16	29	44	151	125	
920 - E6316150	M 16	29	47	176	150	
920 - E6316175	M 16	29	52	201	175	
920 - E6316200	M 16	29	52	226	200	

Fräsaufnahme, HSK-F63 für Einschraubfräser

shank HSK-F63 for threaded type cutter
mandrin HSK-F63 pour fraises à queue fileté

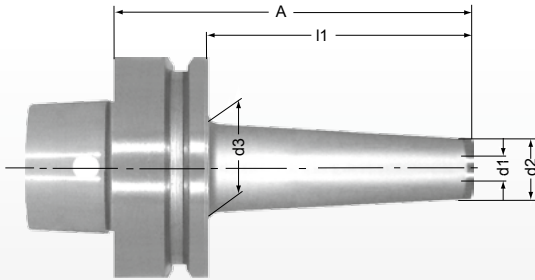

Bestell-Nr. order number No.	d1	d2	d3	A	l1		
920 - F630825	M8	13,8	16	51	25		
920 - F630850	M8	13,8	19	76	50		
920 - F630875	M8	13,8	22	101	75		
920 - F6308100	M8	13,8	24	126	100		
920 - F631025	M10	18	20	51	25		
920 - F631050	M10	18	23	76	50		
920 - F631075	M10	18	26	101	75		
920 - F6310100	M10	18	28	126	100		
920 - F6310125	M10	18	31	151	125		
920 - F6310150	M10	18	34	176	150		
920 - F6310200	M10	18	50	226	200		
920 - F631225	M12	21	23	51	25		
920 - F631250	M12	21	26	76	50		
920 - F631275	M12	21	29	101	75		
920 - F6312100	M12	21	31	126	100		
920 - F6312125	M12	21	34	151	125		
920 - F6312150	M12	21	37	176	150		
920 - F6312200	M12	21	46	226	200		
920 - F6312200ZY	M12	23	23	226	200		
920 - F631625	M16	29	31	51	25		
920 - F631650	M16	29	34	76	50		
920 - F631675	M16	29	37	101	75		
920 - F631675ZY	M16	29	29	101	75		
920 - F6316100	M16	29	39	126	100		
920 - F6316100ZY	M16	29	29	126	100		
920 - F6316125	M16	29	42	151	125		
920 - F6316150	M16	29	45	176	150		
920 - F6316150ZY	M16	29	29	176	150		
920 - F6316175	M16	29	48	201	175		
920 - F6316200	M16	29	50	226	200		
920 - F6316200ZY	M16	29	29	226	200		

G2,5/15.000

Fräsaufnahme, HSK-F63 für Einschraubfräser mit Gewinde für Kühlmittelübergaberohr

shank HSK-F63 for threaded type cutter with thread for coolant tube

mandrin HSK-F63 pour fraises à queue fileté avec filet pour raccord d'arrosage

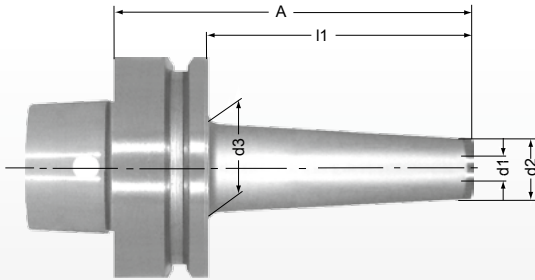

Bestell-Nr. order number No.	d1	d2	d3	A	l1		
920 - F63K0850	M8	13,8	19	76	50		G2,5/15.000
920 - F63K1050	M10	18	23	76	50		
920 - F63K1075	M10	18	26	101	75		
920 - F63K10100	M10	18	28	126	100		
920 - F63K1250	M12	21	26	76	50		
920 - F63K1275	M12	21	29	101	75		
920 - F63K12100	M12	21	31	126	100		
920 - F63K1650	M16	29	34	76	50		
920 - F63K1675	M16	29	37	101	75		
920 - F63K16100	M16	29	39	126	100		

Fräsaufnahmen MAS-BT30 für Einschraubfräser

shank MAS-BT30 for threaded type cutter

mandrin MAS-BT30 pour fraises à queue filetée

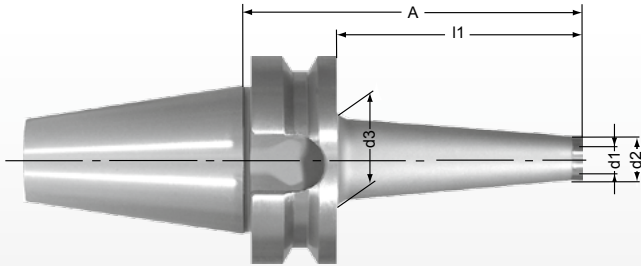

Bestell-Nr. order number No.	d1	d2	d3	A	l1	 G6,3/10.000
962 - BT300825	M8	14	18	47	25	
962 - BT300850	M8	14	23	72	50	
962 - BT301025	M10	18	23	47	25	
962 - BT301050	M10	18	27	72	50	
962 - BT301225	M12	21	25	47	25	
962 - BT301250	M12	21	31	72	50	
962 - BT301625	M16	29	29	47	25	
962 - BT301650	M16	29	34	47	50	

Fräsaufnahmen MAS-BT40 für Einschraubfräser

shank MAS-BT40 for threaded type cutter
mandrin MAS-BT40 pour fraises à queue filetée

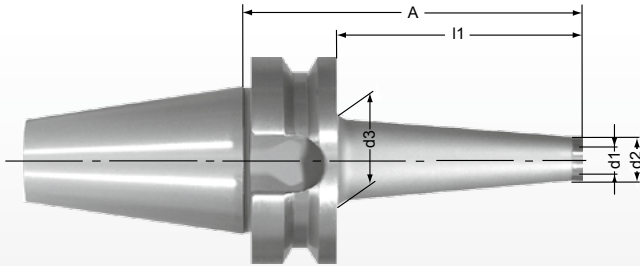

Bestell-Nr. order number No.	d1	d2	d3	A	l1	G6,3/10.000
962 - 0625BT	M6	10	17	52	25	
962 - 0625BTZY	M6	10	10	52	25	
962 - 0650BT	M6	10	23	77	50	
962 - 0675BT	M6	10	25	102	75	
962 - 0825BT	M8	13,8	18	52	25	
962 - 0825BTZY	M8	13,8	13,8	52	25	
962 - 0850BT	M8	13,8	23	77	50	
962 - 0850BTZY	M8	13,8	13,8	77	50	
962 - 0875BT	M8	13,8	25	102	75	
962 - 0875BTZY	M8	13,8	13,8	102	75	
962 - 08100BT	M8	13,8	30	127	100	
962 - 08125BT	M8	13,8	34	152	125	
962 - 1025BT	M10	18	23	52	25	
962 - 1025BTZY	M10	18	18	52	25	
962 - 1050BT	M10	18	25	77	50	
962 - 1050BTZY	M10	18	18	77	50	
962 - 1075BT	M10	18	30	102	75	
962 - 1075BTZY	M10	18	18	102	75	
962 - 10100BT	M10	18	35	127	100	
962 - 10100BTZY	M10	18	18	127	100	
962 - 10125BT	M10	18	40	152	125	
962 - 10150BT	M10	18	45	177	150	

Fräsaufnahmen MAS-BT40 für Einschraubfräser

shank MAS-BT40 for threaded type cutter
mandrin MAS-BT40 pour fraises à queue filetée

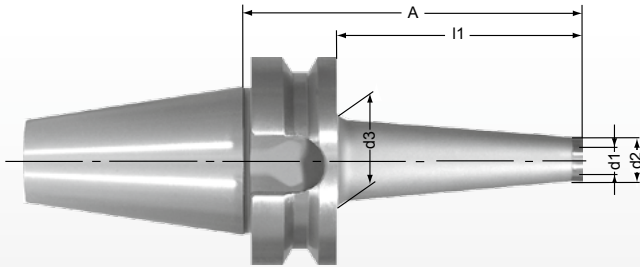

Bestell-Nr. order number No.	d1	d2	d3	A	l1	G6,3/10.000
962 - 1225BT	M12	21	24	52	25	
962 - 1250BT	M12	21	30	77	50	
962 - 1250BTZY	M12	22	22	77	50	
962 - 1275BT	M12	21	35	102	75	
962 - 1275BTZY	M12	22	22	102	75	
962 - 12100BT	M12	21	38	127	100	
962 - 12100BTZY	M12	22	22	127	100	
962 - 12125BT	M12	21	43	152	125	
962 - 12150BT	M12	21	45	177	150	
962 - 1625BT	M16	29	29	52	25	
962 - 1650BT	M16	29	34	77	50	
962 - 1650BTZY	M16	29	29	77	50	
962 - 1675BT	M16	29	35	102	75	
962 - 1675BTZY	M16	29	29	102	75	
962 - 16100BT	M16	29	40	127	100	
962 - 16100BTZY	M16	29	29	127	100	
962 - 16125BT	M16	29	44	152	125	
962 - 16125BTZY	M16	29	29	152	125	
962 - 16150BT	M16	29	45	177	150	
962 - 16175BT	M16	29	50	202	175	
962 - 16200BT	M16	29	50	227	200	
962 - 16225BT	M16	29	50	252	225	
962 - 16250BT	M16	29	50	277	250	

Fräsaufnahmen MAS-BT50 für Einschraubfräser

shank MAS-BT50 for threaded type cutter
mandrin MAS-BT50 pour fraises à queue filetée

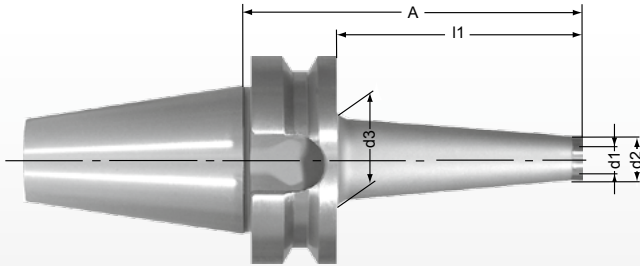

Bestell-Nr. order number No.	d1	d2	d3	A	l1	G6,3/8.000
963 - 0850BT	M8	13,8	23	88	50	
963 - 08100BT	M8	13,8	30	138	100	
963 - 08150BT	M8	13,8	35	188	150	
963 - 1050BT	M10	18	25	88	50	
963 - 10100BT	M10	18	35	138	100	
963 - 10150BT	M10	18	38	188	150	
963 - 1250BT	M12	21	34	88	50	
963 - 1250BTZY	M12	22	22	88	50	
963 - 1275BT	M12	21	37	113	75	
963 - 1275BTZY	M12	22	22	113	75	
963 - 12100BT	M12	21	41	138	100	
963 - 12100BTZY	M12	22	22	138	100	
963 - 12150BT	M12	21	50	188	150	
963 - 12200BT	M12	21	57	238	200	
963 - 12250BT	M12	21	62	288	250	
963 - 12300BT	M12	21	67	338	300	
963 - 1650BT	M16	29	35	88	50	
963 - 1650BTZY	M16	29	29	88	50	
963 - 1675BT	M16	29	37	113	75	
963 - 1675BTZY	M16	29	29	113	75	
963 - 16100BT	M16	29	41	138	100	
963 - 16100BTZY	M16	29	29	138	100	
963 - 16150BT	M16	29	50	188	150	
963 - 16150BTZY	M16	29	29	188	150	
963 - 16200BT	M16	29	57	238	200	
963 - 16200BTZY	M16	29	29	238	200	
963 - 16250BT	M16	29	62	288	250	
963 - 16300BT	M16	29	67	338	300	

Fräsaufnahme PSC-63 für Einschraubfräser

mandrini PSC-63 per frese con attacco filettato
shank PSC-63 for threadet type cutter

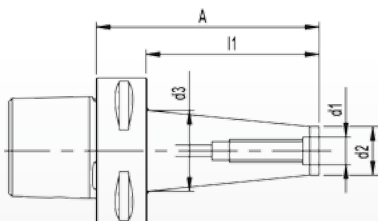

Bestell-Nr. order number No.	d1	d2	d3	A	l1		
920-PSC631050	M10	18	25	72	50		G2,5/15.000
920-PSC631050zy	M10	18	18	72	50		
920-PSC631075	M10	18	30	97	75		
920-PSC631075zy	M10	18	18	97	75		
920-PSC6310100	M10	18	35	122	100		
920-PSC631250	M12	21	30	72	50		
920-PSC631250zy	M12	23	23	72	50		
920-PSC631275	M12	21	35	97	75		
920-PSC631275zy	M12	23	23	97	75		
920-PSC6312100	M12	21	38	122	100		
920-PSC631650	M16	29	34	72	50		
920-PSC631650zy	M16	29	29	72	50		
920-PSC631675	M16	29	35	97	75		
920-PSC631675zy	M16	29	29	97	75		
920-PSC6316100	M16	29	40	122	100		

Fräsaufnahmen SK30 für Einschraubfräser

shank SK30 for threaded type cutter

mandrin SK30 pour fraises à queue filetée

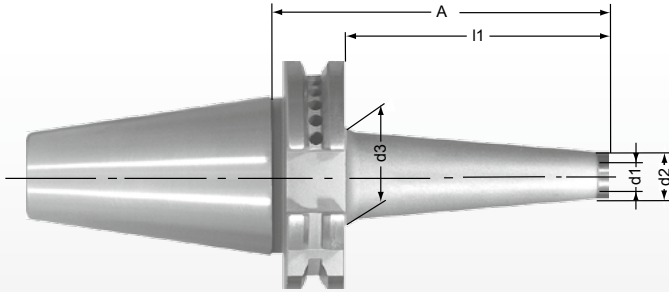

Bestell-Nr. order number No.	d1	d2	d3	A	l1	G6,3/10.000
962 - SK300625	M6	10	17	44,1	25	
962 - SK300650	M6	10	20	69,1	50	
962 - SK300825	M8	14	18	44,1	25	
962 - SK300850	M8	14	23	69,1	50	
962 - SK301025	M10	18	23	44,1	25	
962 - SK301050	M10	18	27	69,1	50	
962 - SK301225	M12	21	25	44,1	25	
962 - SK301250	M12	21	31	69,1	50	
962 - SK301625	M16	29	29	44,1	25	
962 - SK301650	M16	29	34	69,1	50	

Fräsaufnahmen SK40 für Einschraubfräser

shank SK40 for threaded type cutter
mandrin SK40 pour fraises à queue filetée

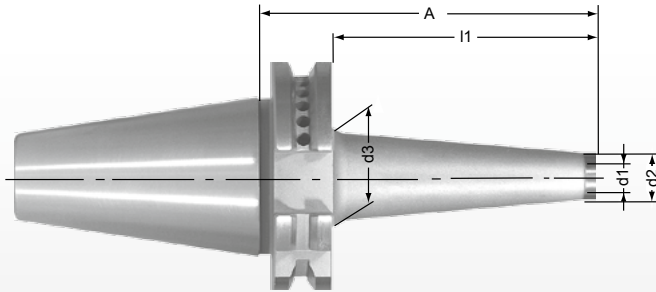

Bestell-Nr. order number No.	d1	d2	d3	A	l1	
962 - 0625	M6	10	17	44,1	25	
962 - 0625ZY	M6	10	10	44,1	25	
962 - 0650	M6	10	23	69,1	50	
962 - 0675	M6	10	25	94,1	75	
962 - 0825	M8	13,8	18	44,1	25	
962 - 0825ZY	M8	13,8	13,8	44,1	25	
962 - 0850	M8	13,8	23	69,1	50	
962 - 0850ZY	M8	13,8	13,8	69,1	50	
962 - 0875	M8	13,8	25	94,1	75	
962 - 0875ZY	M8	13,8	13,8	94,1	75	
962 - 08100	M8	13,8	30	119,1	100	
962 - 08125	M8	13,8	34	144,1	125	
962 - 1025K	M10	15,4	18	44,1	25	
962 - 1050K	M10	15,4	21	69,1	50	
962 - 1025	M10	18	23	44,1	25	
962 - 1025ZY	M10	18	18	44,1	25	
962 - 1050	M10	18	25	69,1	50	
962 - 1050ZY	M10	18	18	69,1	50	
962 - 1075	M10	18	30	94,1	75	
962 - 1075ZY	M10	18	18	94,1	75	
962 - 10100	M10	18	35	119,1	100	
962 - 10100ZY	M10	18	18	119,1	100	
962 - 10125	M10	18	40	144,1	125	
962 - 10150	M10	18	45	169,1	150	

Fräsaufnahmen SK40 für Einschraubfräser

shank SK40 for threaded type cutter
mandrin SK40 pour fraises à queue filetée

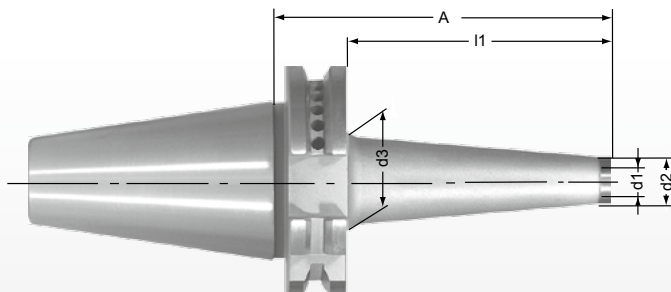



Bestell-Nr. order number No.	d1	d2	d3	A	l1	
962 - 1225	M12	21	24	44,1	25	
962 - 1250	M12	21	30	69,1	50	
962 - 1250ZY	M12	22	22	69,1	50	
962 - 1275	M12	21	35	94,1	75	
962 - 1275ZY	M12	22	22	94,1	75	
962 - 12100	M12	21	38	119,1	100	
962 - 12100ZY	M12	22	22	119,1	100	
962 - 12125	M12	21	43	144,1	125	
962 - 12150	M12	21	45	169,1	150	
962 - 12175	M12	21	50	194,1	175	
962 - 12200	M12	21	50	219,1	200	
962 - 1625	M16	29	29	44,1	25	
962 - 1650	M16	29	34	69,1	50	
962 - 1650-37	M16	37	43	69,1	50	
962 - 1650ZY	M16	29	29	69,1	50	
962 - 1675	M16	29	35	94,1	75	
962 - 1675-37	M16	37	46	94,1	75	
962 - 1675ZY	M16	29	29	94,1	75	
962 - 16100	M16	29	40	119,1	100	
962 - 16100-37	M16	37	49	119,1	100	
962 - 16100ZY	M16	29	29	119,1	100	
962 - 16125	M16	29	44	144,1	125	
962 - 16150	M16	29	45	169,1	150	
962 - 16150ZY	M16	29	29	169,1	150	
962 - 16175	M16	29	50	194,1	175	
962 - 16200	M16	29	50	219,1	200	
962 - 16200ZY	M16	29	29	219,1	200	
962 - 16225	M16	29	50	244,1	225	
962 - 16250	M16	29	50	269,1	250	

Fräsaufnahmen SK40 für Einschraubfräser

shank SK40 for threaded type cutter
mandrin SK40 pour fraises à queue fileté

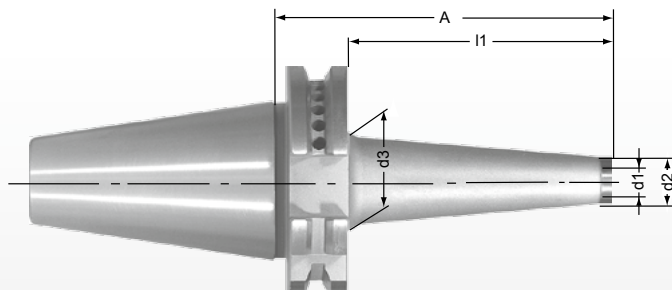
Form AD/B





Bestell-Nr. order number No.	d1	d2	d3	A	l1	
920 - SK400825	M8	13,8	18	44,1	25	
920 - SK400825ZY	M8	13,8	13,8	44,1	25	
920 - SK400850	M8	13,8	23	69,1	50	
920 - SK400850ZY	M8	13,8	13,8	69,1	50	
920 - SK400875	M8	13,8	25	94,1	75	
920 - SK400875ZY	M8	13,8	13,8	94,1	75	
920 - SK4008100	M8	13,8	30	119,1	100	
920 - SK4008125	M8	13,8	34	144,1	125	
920 - SK401025	M10	18	23	44,1	25	
920 - SK401025ZY	M10	18	18	44,1	25	
920 - SK401050	M10	18	25	69,1	50	
920 - SK401050ZY	M10	18	18	69,1	50	
920 - SK401075	M10	18	30	94,1	75	
920 - SK401075ZY	M10	18	18	94,1	75	
920 - SK4010100	M10	18	35	119,1	100	
920 - SK4010100ZY	M10	18	18	119,1	100	
920 - SK4010150	M10	18	45	169,1	150	
920 - SK401225	M12	21	24	44,1	25	
920 - SK401250	M12	21	30	69,1	50	
920 - SK401250ZY	M12	22	22	69,1	50	
920 - SK401275	M12	21	35	94,1	75	
920 - SK401275ZY	M12	22	22	94,1	75	
920 - SK4012100	M12	21	38	119,1	100	
920 - SK4012100ZY	M12	22	22	119,1	100	
920 - SK401625	M16	29	29	44,1	25	
920 - SK401650	M16	29	34	69,1	50	
920 - SK401650ZY	M16	29	29	69,1	50	
920 - SK401675	M16	29	35	94,1	75	
920 - SK401675ZY	M16	29	29	94,1	75	
920 - SK4016100	M16	29	40	119,1	100	
920 - SK4016100ZY	M16	29	29	119,1	100	
920 - SK4016125	M16	29	44	144,1	125	
920 - SK4016150	M16	29	45	169,1	150	
920 - SK4016175	M16	29	50	194,1	175	
920 - SK4016200	M16	29	50	219,1	200	
920 - SK4016225	M16	29	50	244,1	225	

G6,3/10.000

Fräsaufnahmen SK50 für Einschraubfräser

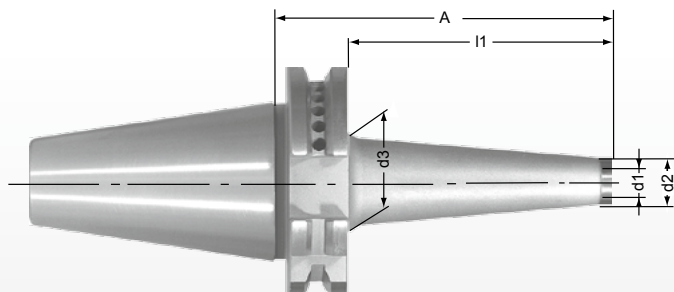
shank SK50 for threaded type cutter
mandrin SK50 pour fraises à queue filetée



Bestell-Nr. order number No.	d1	d2	d3	A	l1	
963 - 0850	M8	13,8	23	69,1	50	G6,3/8.000
963 - 0875	M8	13,8	25	94,1	75	
963 - 08100	M8	13,8	30	119,1	100	
963 - 08150	M8	13,8	35	169,1	150	
963 - 1050	M10	18	25	69,1	50	
963 - 1050ZY	M10	18	18	69,1	50	
963 - 1075	M10	18	30	94,1	75	
963 - 10100	M10	18	35	119,1	100	
963 - 10150	M10	18	38	169,1	150	
963 - 1250	M12	21	34	69,1	50	
963 - 1250ZY	M12	22	22	69,1	50	
963 - 1275	M12	21	37	94,1	75	
963 - 1275ZY	M12	22	22	94,1	75	
963 - 12100	M12	21	41	119,1	100	
963 - 12100ZY	M12	22	22	119,1	100	
963 - 12150	M12	21	50	169,1	150	
963 - 12150ZY	M12	23	23	169,1	150	
963 - 12200	M12	21	57	219,1	200	
963 - 12250	M12	21	62	269,1	250	
963 - 12300	M12	21	67	319,1	300	
963 - 12350	M12	21	70	369,5	350	

Fräsaufnahmen SK50 für Einschraubfräser

shank SK50 for threaded type cutter
mandrin SK50 pour fraises à queue fileté

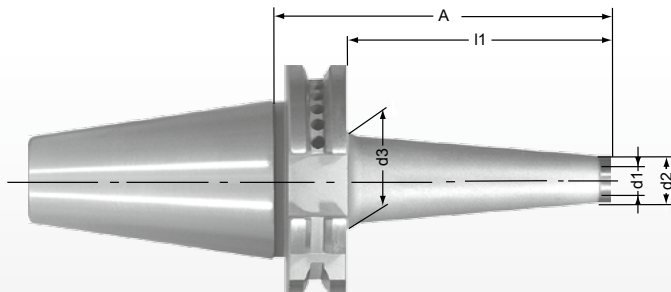

Bestell-Nr. order number No.	d1	d2	d3	A	l1	G6,3/8.000
963 - 1650	M16	29	35	69,1	50	
963 - 1650-37	M16	37	43	69,1	50	
963 - 1650ZY	M16	29	29	69,1	50	
963 - 1675	M16	29	37	94,1	75	
963 - 1675-37	M16	37	46	94,1	75	
963 - 1675ZY	M16	29	29	94,1	75	
963 - 1675ZY-37	M16	37	37	94,1	75	
963 - 16100	M16	29	41	119,1	100	
963 - 16100-37	M16	37	49	119,1	100	
963 - 16100ZY	M16	29	29	119,1	100	
963 - 16100ZY-37	M16	37	37	119,1	100	
963 - 16150	M16	29	50	169,1	150	
963 - 16150ZY	M16	29	29	169,1	150	
963 - 16200	M16	29	57	219,1	200	
963 - 16200ZY	M16	29	29	219,1	200	
963 - 16250	M16	29	62	269,1	250	
963 - 16250ZY-38	M16	38	38	269,1	250	
963 - 16300	M16	29	67	319,1	300	
963 - 16350	M16	29	70	369,1	350	
963 - 16400	M16	29	70	419,1	400	

Fräsaufnahmen SK50 für Einschraubfräser

shank SK50 for threaded type cutter

mandrin SK50 pour fraises à queue filetée

Form AD/B

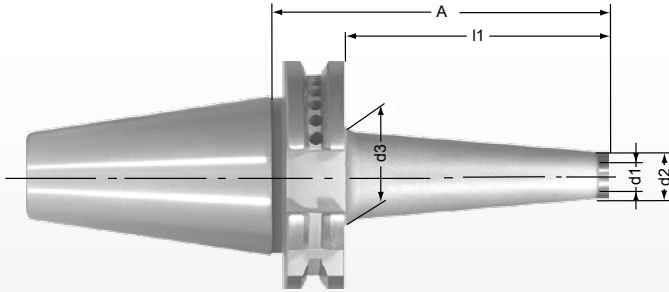

Bestell-Nr. order number No.	d1	d2	d3	A	l1	
920 - SK501275	M12	21	37	94,1	75	G6,3/8.000
920 - SK5012100	M12	21	41	119,1	100	
920 - SK5012150	M12	21	50	169,1	150	
920 - SK501675	M16	29	37	94,1	75	
920 - SK5016100	M16	29	41	119,1	100	
920 - SK5016150	M16	29	50	169,1	150	

Hartmetallverlängerungen für Einschraubfräser

adapters for threaded type cutters

adaptateur en métal dur pour fraises à queue filetée

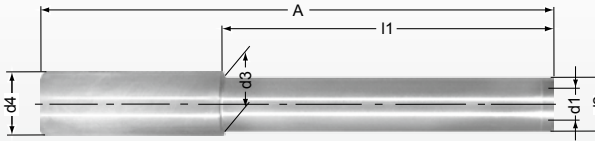
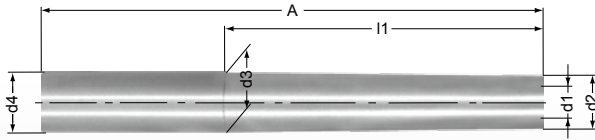

Bestell-Nr. order number No.	d1	d2	d3	d4	A	l1		
979HM - 120620ZY	M6	9,8	9,8	12	65	20		
979HM - 120640	M6	9,8	11,5	12	85	40		
979HM - 120640ZY	M6	9,8	9,8	12	85	40		
979HM - 120660	M6	9,8	11,5	12	105	60		
979HM - 120660ZY	M6	9,8	9,8	12	105	60		
979HM - 120680	M6	9,8	11,5	12	125	80		
979HM - 120680ZY	M6	9,8	9,8	12	125	80		
979HM - 1206100	M6	9,8	11,5	12	145	100		
979HM - 120720ZY	M7	11,5	11,5	12	65	20		
979HM - 120740ZY	M7	11,5	11,5	12	85	40		
979HM - 120760ZY	M7	11,5	11,5	12	105	60		
979HM - 120780ZY	M7	11,5	11,5	12	125	80		
979HM - 1607100	M7	11,5	15,5	16	148	100		
979HM - 160820ZY	M8	13,6	13,6	16	68	20		
979HM - 160840	M8	13,6	15,5	16	88	40		
979HM - 160840ZY	M8	13,6	13,6	16	88	40		
979HM - 160840ZY-12,5	M8	12,5	12,5	16	88	40		
979HM - 160860	M8	13,6	15,5	16	108	60		
979HM - 160860ZY	M8	13,6	13,6	16	108	60		
979HM - 160860ZY-12,5	M8	12,5	12,5	16	108	60		
979HM - 160880	M8	13,6	15,5	16	128	80		
979HM - 160880ZY	M8	13,6	13,6	16	128	80		
979HM - 1608100	M8	13,6	15,5	16	148	100		
979HM - 1608100ZY	M8	13,6	13,6	16	148	100		
979HM - 1608120	M8	13,6	15,5	16	168	120		
979HM - 161020ZY-15,4	M10	15,4	15,4	16	68	20		
979HM - 161040ZY-15,4	M10	15,4	15,4	16	88	40		
979HM - 161060ZY-15,4	M10	15,4	15,4	16	108	60		
979HM - 161080ZY-15,4	M10	15,4	15,4	16	128	80		
979HM - 1610100ZY-15,4	M10	15,4	15,4	16	148	100		
979HM - 1610120ZY-15,4	M10	15,4	15,4	16	168	120		
979HM - 1610205ZY-15,4	M10	15,4	15,4	16	250	205		

Hartmetallverlängerungen für Einschraubfräser

adapters for threaded type cutters

adaptateur en métal dur pour fraises à queue filetée

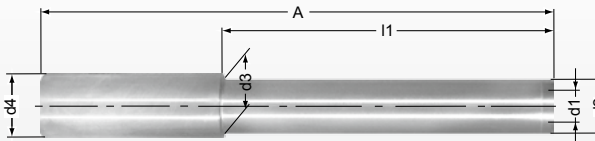
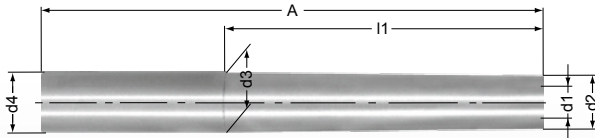

Bestell-Nr. order number No.	d1	d2	d3	d4	A	l1		
979HM - 201040	M10	18	19,5	20	90	40		
979HM - 201060	M10	18	19,5	20	110	60		
979HM - 201080	M10	18	19,5	20	130	80		
979HM - 201080-15,4	M10	15,4	19,5	20	130	80		
979HM - 2010100	M10	18	19,5	20	150	100		
979HM - 2010100-15,4	M10	15,4	19,5	20	150	100		
979HM - 2010120	M10	18	19,5	20	170	120		
979HM - 2010120-15,4	M10	15,4	19,5	20	170	120		
979HM - 2010150	M10	18	19,5	20	200	150		
979HM - 2010150-15,4	M10	15,4	19,5	20	200	150		
979HM - 2010200	M10	19	19	20	250	200		
979HM - 251240ZY	M12	23	23	25	96	40		
979HM - 251275	M12	21	24,5	25	131	75		
979HM - 251275ZY	M12	23	23	25	131	75		
979HM - 2512100	M12	21	24,5	25	156	100		
979HM - 2512100ZY	M12	23	23	25	156	100		
979HM - 2512125	M12	21	24,5	25	181	125		
979HM - 2512150	M12	21	24,5	25	206	150		
979HM - 2512175	M12	21	24,5	25	231	175		
979HM - 3216100	M16	29	31,5	32	160	100		
979HM - 3216150	M16	29	31,5	32	210	150		
979HM - 3216200	M16	29	31,5	32	260	200		

Frässtangen mit zyl. Schaft für Einschraubfräser

adapters for threaded type cutter
 adaptateur cylindrique pour fraises à queue filetée

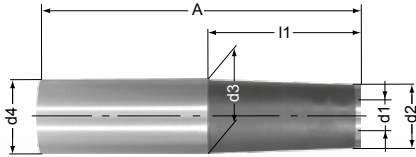

Bestell-Nr. order number No.	d1	d2	d3	d4	A	l1		
978 - 120510	M5	10	11,5	12	55	10		
978 - 120520	M5	10	11,5	12	65	20		
978 - 120620	M6	10	11,5	12	65	20		
978 - 160820	M8	13,8	15,5	16	68	20		
978 - 160825ZY	M8	13,8	13,8	16	73	25		
978 - 160840	M8	13,8	15,5	16	88	40		
978 - 201025	M10	18	19,5	20	75	25		
978 - 201045	M10	18	19,5	20	95	45		
978 - 251230	M12	21	24,5	25	86	30		
978 - 251250	M12	21	24,5	25	106	50		
978 - 321630	M16	29	31,5	32	90	30		
978 - 321650	M16	29	31,5	32	110	50		
978 - 3216100	M16	29	31,5	32	160	100		

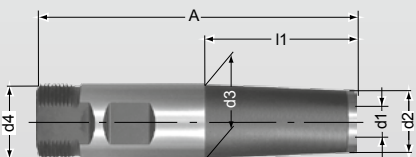

Bestell-Nr. order number No.	d1	d2	d3	d4	A	l1		
975 - 120510	M5	10	11,5	12	55	10		
975 - 120520	M5	10	11,5	12	65	20		
975 - 120620	M6	10	11,5	12	65	20		
975 - 160820	M8	13,8	15,5	16	68	20		
975 - 160840	M8	13,8	15,5	16	88	40		
975 - 201025	M10	18	19,5	20	75	25		
975 - 201045	M10	18	19,5	20	95	45		
975 - 251230	M12	21	24,5	25	86	30		
975 - 251250	M12	21	24,5	25	106	50		
975 - 321630	M16	29	31,5	32	90	30		
975 - 321650	M16	29	31,5	32	110	50		

Schwermetallverlängerungen für Einschraubfräser

densimet adapters for threaded type cutters
 adaptateur en densimet pour fraises à queue fileté

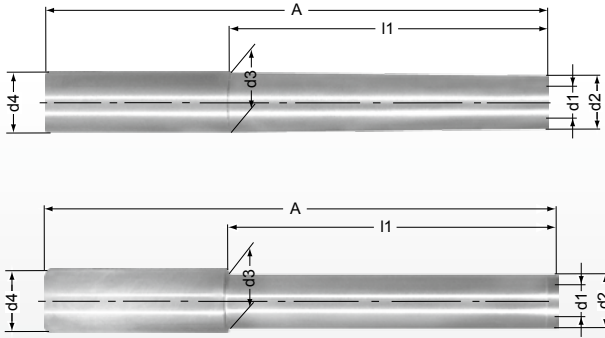

Nur auf Anfrage lieferbar

Only on request
 Seulement sur demande



Bestell-Nr. order number No.	d1	d2	d3	d4	A	l1		
979 - 120540	M5	10	11,5	12	85	40		
979 - 120560	M5	10	11,5	12	105	60		
979 - 120580	M5	10	11,5	12	125	80		
979 - 120640	M6	10	11,5	12	85	40		
979 - 120640ZY	M6	9,8	9,8	12	85	40		
979 - 120660	M6	10	11,5	12	104	60		
979 - 120660ZY	M6	9,8	9,8	12	105	60		
979 - 120680	M6	10	11,5	12	125	80		
979 - 120680ZY	M6	9,8	9,8	12	125	80		
979 - 1206100	M6	10	11,5	12	145	100		
979 - 160840	M8	13,6	15,5	16	88	40		
979 - 160840ZY	M8	13,6	13,6	16	88	40		
979 - 160860	M8	13,6	15,5	16	108	60		
979 - 160860ZY	M8	13,6	13,6	16	108	60		
979 - 160880	M8	13,6	15,5	16	128	80		
979 - 160880ZY	M8	13,6	13,6	16	128	80		
979 - 1608100	M8	13,6	15,5	16	148	100		
979 - 1608100ZY	M8	13,6	13,6	16	148	100		
979 - 1608120	M8	13,6	15,5	16	168	120		
979 - 201040	M10	18	19,5	20	90	40		
979 - 201060	M10	18	19,5	20	110	60		
979 - 201080	M10	18	19,5	20	130	80		
979 - 2010100	M10	18	19,5	20	150	100		
979 - 2010120	M10	18	19,5	20	170	120		
979 - 2510140	M10	18	24,5	25	196	140		
979 - 251275	M12	21	24,5	20	131	75		
979 - 2512100	M12	21	24,5	25	156	100		
979 - 2512125	M12	21	24,5	25	181	125		
979 - 2512150	M12	21	24,5	25	206	150		
979 - 2512175	M12	21	24,5	25	231	175		
979 - 3216100	M16	29	31,5	32	160	100		
979 - 3216150	M16	29	31,5	32	210	150		
979 - 3216200	M16	29	31,5	32	260	200		

Verlängerungen/Reduzierungen für Einschraubfräser

extensions/reducers for threaded type cutter
 rallonge/douilles pour fraises à queue filetée

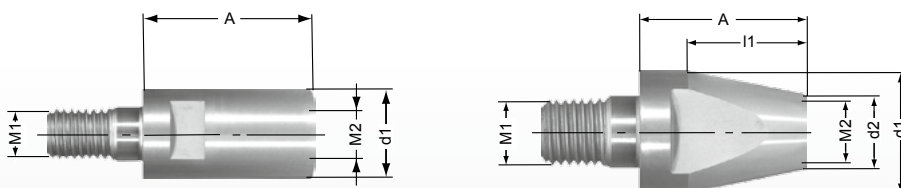

Verlängerungen für Einschraubfräser

extensions for threaded type cutter
 rallonge pour fraises à queue filetée



Bestell-Nr. order number No.	M1	M2	d1	d2	A	l1		
976 - 0840	8	8	13,8	-	40	-		
976 - 0860	8	8	13,8	-	60	-		
976 - 1040	10	10	18	-	40	-		
976 - 1060	10	10	18	-	60	-		
976 - 1240	12	12	21	-	40	-		
976 - 1260	12	12	21	-	60	-		
976 - 1640	16	16	29	-	40	-		
976 - 1660	16	16	29	-	60	-		

Reduzierungen für Einschraubfräser

reducers for threaded type cutter
 douilles de réduction pour fraises à queue filetée



Bestell-Nr. order number No.	M1	M2	d1	d2	A	l1		
977 - 080640	8	6	13,8	10	40	25		
977 - 100640	10	6	18	10	40	32		
977 - 100840	10	8	18	13,8	40	25		
977 - 120840	12	8	21	13,8	40	32		
977 - 120860	12	8	21	13,8	60	52		
977 - 121040	12	10	21	18	40	15		
977 - 121060	12	10	21	18	60	40		
977 - 160840	16	8	29	13,8	40	35		
977 - 161040	16	10	29	18	40	28		
977 - 161060	16	10	29	18	60	48		
977 - 161240	16	12	29	21	40	19		
977 - 161260	16	12	29	21	60	39		

Frässtangen mit Morsekegel für Einschraubfräser

adapters with morse taper for threaded type cutter
 adaptateur avec cône morse pour fraises à queue filetée

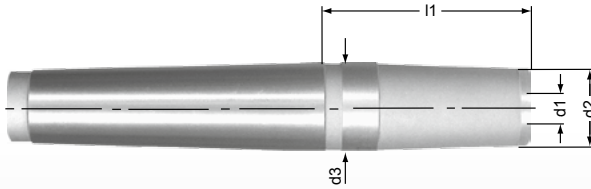

Bestell-Nr. order number No.	MK	d1	d2	d3	l1			
MK1 - 0605	MK1	M6	9,8	9,8	5			
MK1 - 0620	MK1	M6	9,8	9,8	20			
MK1 - 0640	MK1	M6	9,8	9,8	40			
MK1 - 0660	MK1	M6	9,8	12	60			
MK2 - 0640	MK2	M6	9,8	18	40			
MK2 - 0660	MK2	M6	9,8	18	60			
MK2 - 0680	MK2	M6	9,8	18	80			
MK2 - 0820	MK2	M8	13,8	18	20			
MK2 - 0840	MK2	M8	13,8	18	40			
MK2 - 0860	MK2	M8	13,8	18	60			
MK2 - 1020	MK2	M10	18	18	20			
MK2 - 1040	MK2	M10	18	18	40			
MK2 - 1060	MK2	M10	18	18	60			
MK3 - 0880	MK3	M8	13,8	24	80			
MK3 - 08100	MK3	M8	13,8	24	100			
MK3 - 1080	MK3	M10	18	24	80			
MK3 - 10100	MK3	M10	18	24	100			
MK3 - 1210	MK3	M12	21	24	10			
MK3 - 1230	MK3	M12	21	24	30			
MK3 - 1245	MK3	M12	21	24	45			
MK3 - 1260	MK3	M12	21	24	60			
MK3 - 1275	MK3	M12	21	24	75			
MK3 - 1285	MK3	M12	21	24	85			
MK3 - 1295	MK3	M12	21	24	95			
MK3 - 12110	MK3	M12	21	24	110			
MK4 - 12120	MK4	M12	21	31,5	120			
MK4 - 1610	MK4	M16	29	29	10			
MK4 - 1635	MK4	M16	29	31,5	35			
MK4 - 1650	MK4	M16	29	31,5	50			
MK4 - 1665	MK4	M16	29	31,5	65			
MK4 - 1680	MK4	M16	29	31,5	80			
MK4 - 1695	MK4	M16	29	31,5	95			
MK4 - 16110	MK4	M16	29	31,5	110			
MK4 - 16125	MK4	M16	29	31,5	125			
MK4 - 16150	MK4	M16	29	31,5	150			
MK5 - 16100	MK5	M16	29	45	100			
MK5 - 16120	MK5	M16	29	45	120			
MK5 - 16150	MK5	M16	29	45	150			
MK5 - 16180	MK5	M16	29	45	180			
MK5 - 16220	MK5	M16	29	45	220			
MK5 - 16260	MK5	M16	29	45	260			